

NOTES:

1. MATERIAL: HEAVY GAUGE WELDED STEEL
2. FINISH: POWDER COAT ASA 61 GRAY
3. APPROXIMATE UNPACKAGED RACK WEIGHT: 124 LBS.
4. FRAME CONSTRUCTION, BATTERY SUPPORT RAIL DESIGN, AND SEISMIC BRACKET OPTIONS ARE SEISMIC CERTIFIED TO UBC (UNIFORM BUILDING CODE) SECTION 1632.

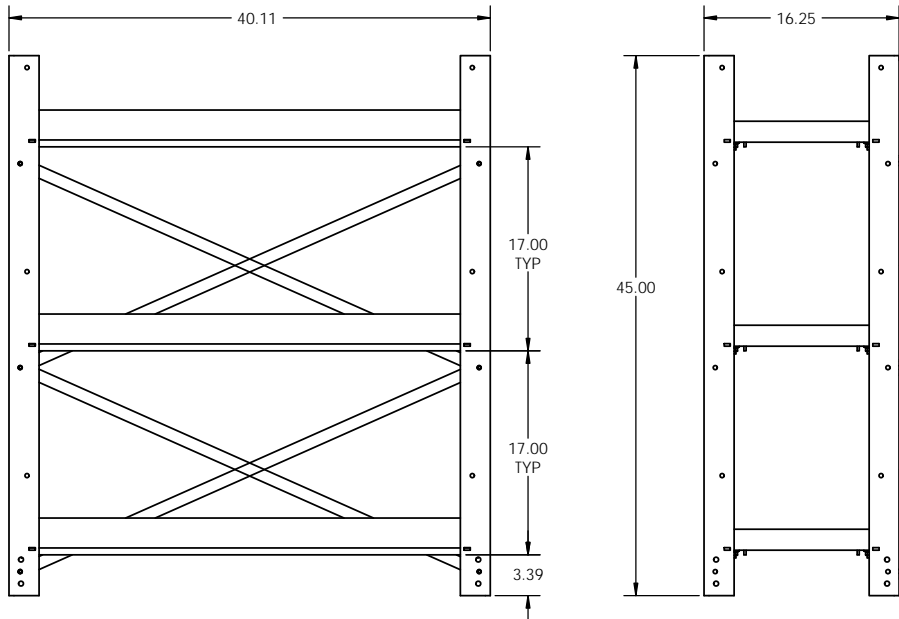

BATTERIES SHOWN FOR
REFERENCE ONLY.
SOLD SEPARATELY

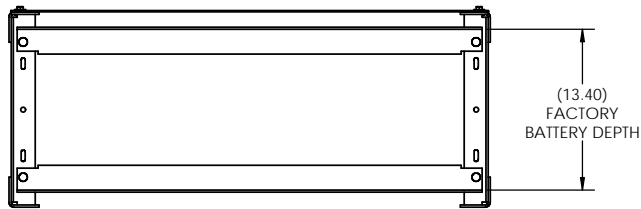
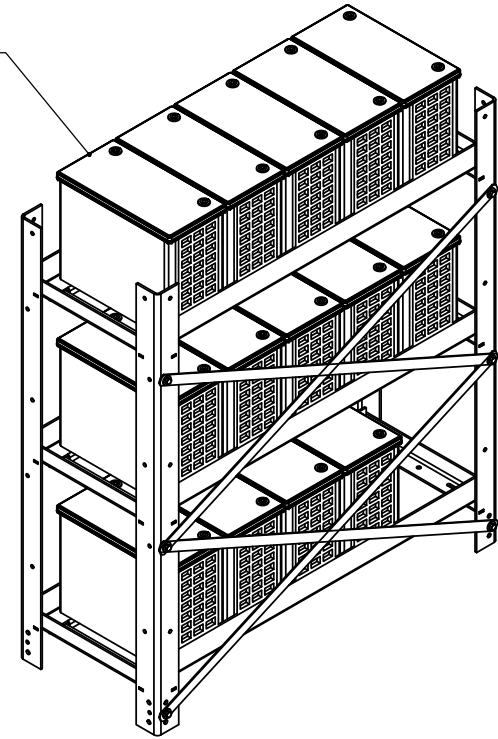

MAX BATTERY CAPACITY	
BATTERY TYPE	QTY
100 wpc	21
250 wpc - 800 wpc	15

PROPRIETARY AND CONFIDENTIAL
THE INFORMATION CONTAINED IN THIS DRAWING IS THE SOLE PROPERTY OF ELECTRONIC SYSTEMS SUPPORT. ANY REPRODUCTION IN PART OR AS A WHOLE WITHOUT THE WRITTEN PERMISSION OF ELECTRONIC SYSTEMS SUPPORT IS PROHIBITED.

UNLESS OTHERWISE SPECIFIED: DIMENSIONS ARE IN INCHES		 Electronic Systems Support www.ess.to		3233 W. Kingsley Rd. Garland, Texas 75041 PH. 972-272-2468 FAX 972-276-9844	
TITLE: BATTERY RACK, VRLA, 3 TIER/5 WIDE, NON-SEISMIC					
PROJECTION: 	NAME: RNA	DATE: 07-20-09	SIZE: C	DWG. NO.: R3T5-SPEC	REV: B
SCALE: 1:8				SHEET 1 OF 1	