

NOTES:

1. MATERIAL: HEAVY GAUGE WELDED STEEL
2. FINISH: TELCO GRAY POWDER COAT
(OTHER COLORS AVAILABLE, SEE PART NUMBER LEGEND)
3. IT IS RECOMMENDED TO SUPPORT RACKS TALLER THAN 8 FT. FROM TOP IN ADDITION TO FLOOR MOUNTING.
4. APPROXIMATE UNPACKAGED WEIGHT: 68 LBS (84" TALL RACK)

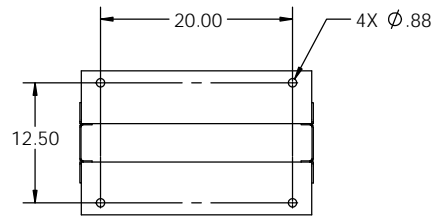

SECTION B-B
SCALE 1 : 10

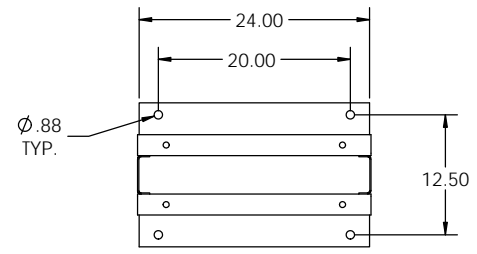
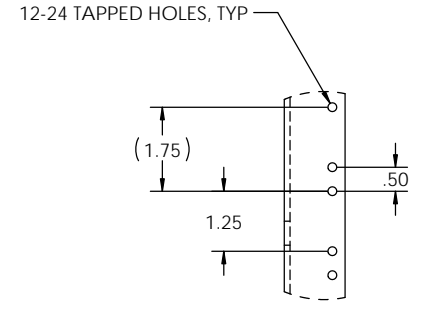
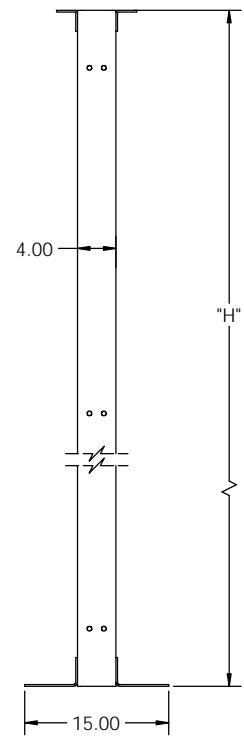
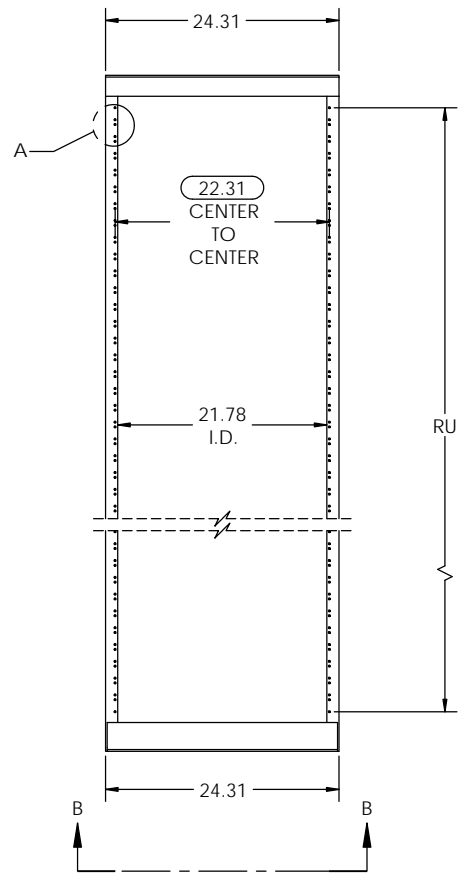

DETAIL A
EIA HOLE SPACING

EQUIPMENT RACK PART NUMBER LEGEND

EOR 2 B 084 A A

RACK COLOR	
A	TELCO GRAY
B	BLACK
C	BLUE
D	WHITE
E	CREAM
F	KONE GRAY

HOLE SPACING	
A	EIA

RACK HIEGHT		
	H	RU(EIA)
060	5'	30
066	5'6"	34
072	6'	37
078	6'6"	41
084	7'	44
090	7'6"	47
096	8'	51
108	9'	58
138	11'6"	75

RACK WIDTH	
B	23" PANEL MOUNTING

RACK STYLE	
2	STANDARD

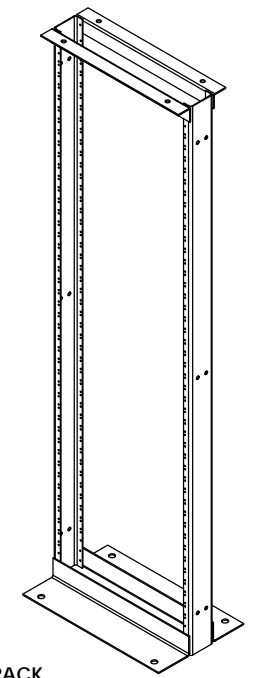

EIA RACK

PROPRIETARY AND CONFIDENTIAL
THE INFORMATION CONTAINED IN THIS DRAWING IS THE SOLE PROPERTY OF ELECTRONIC SYSTEMS SUPPORT. ANY REPRODUCTION IN PART OR AS A WHOLE WITHOUT THE WRITTEN PERMISSION OF ELECTRONIC SYSTEMS SUPPORT IS PROHIBITED.

UNLESS OTHERWISE SPECIFIED: DIMENSIONS ARE IN INCHES		Electronic Systems Support www.ess.io		3233 W. Kingsley Rd. Garland, Texas 75041 PH. 972-272-2468 FAX 972-276-9844	
TITLE: EQ. RACK, 23" PANEL MNTG., 4" CHANNEL, LIGHT DUTY					
PROJECTION:	NAME: RNA	DATE: 03-07-17	SIZE: C	DWG. NO.: EOR2Bxxxxx-SPEC	REV: B
SCALE: 1:24				SHEET 1 OF 2	

NOTES:

1. MATERIAL: HEAVY GAUGE WELDED STEEL
2. FINISH: TELCO GRAY POWDER COAT (OTHER COLORS AVAILABLE, SEE PART NUMBER LEGEND)
3. IT IS RECOMMENDED TO SUPPORT RACKS TALLER THAN 8 FT. FROM TOP IN ADDITION TO FLOOR MOUNTING.
4. APPROXIMATE UNPACKAGED WEIGHT: 68 LBS (84" TALL RACK)

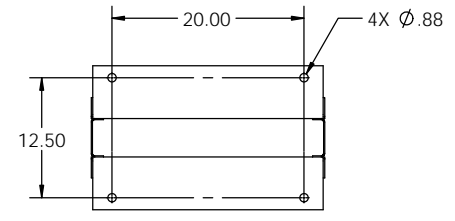
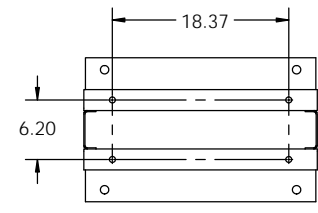

SECTION D-D
SCALE 1 : 10

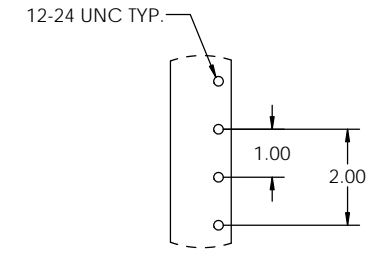
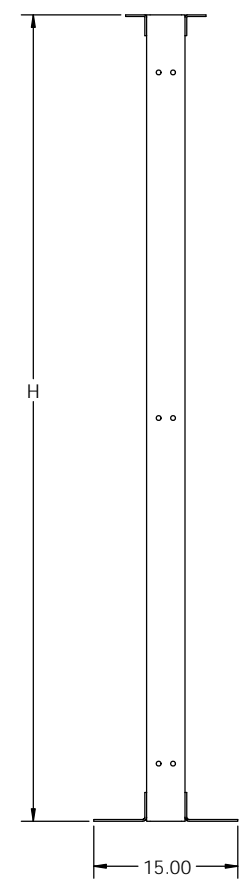
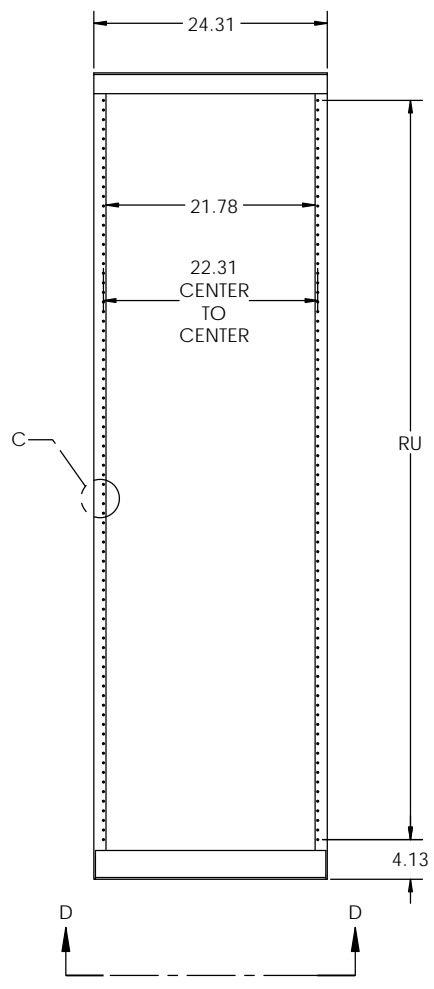

DETAIL C
SCALE 1 : 2
WECO HOLE SPACING

EQUIPMENT RACK PART NUMBER LEGEND

EOR 2 B 084 B A

RACK COLOR	
A	TELCO GRAY
B	BLACK
C	BLUE
D	WHITE
E	CREAM
F	KONE GRAY

HOLE SPACING	
B	WECO

RACK HIEGHT		
	H	RU(WECO)
060	5'	27
066	5'6"	30
072	6'	33
078	6'6"	36
084	7'	39
090	7'6"	42
096	8'	45
108	9'	51
138	11'6"	66

RACK WIDTH	
B	23" PANEL MOUNTING

RACK STYLE	
2	STANDARD

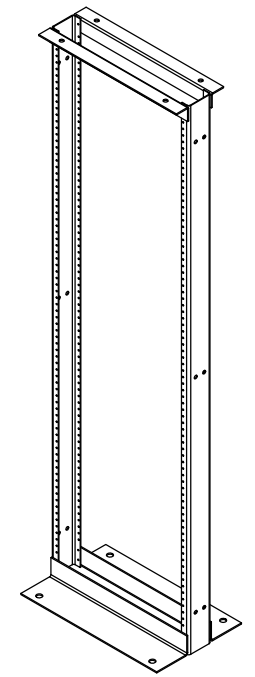

WECO RACK

PROPRIETARY AND CONFIDENTIAL
THE INFORMATION CONTAINED IN THIS DRAWING IS THE SOLE PROPERTY OF ELECTRONIC SYSTEMS SUPPORT. ANY REPRODUCTION IN PART OR AS A WHOLE WITHOUT THE WRITTEN PERMISSION OF ELECTRONIC SYSTEMS SUPPORT IS PROHIBITED.

UNLESS OTHERWISE SPECIFIED: DIMENSIONS ARE IN INCHES		Electronic Systems Support www.ess.io		3233 W. Kingsley Rd. Garland, Texas 75041 PH. 972-272-2468 FAX 972-276-9844	
TITLE: EQ. RACK, 23" PANEL MNTG., 4" CHANNEL, LIGHT DUTY					
PROJECTION:	NAME: RNA	DATE: 03-07-17	SIZE: C	DWG. NO.: EOR2Bxxxxx-SPEC	REV: B
SCALE: 1:24				SHEET 2 OF 2	