

NOTES:

1. MATERIAL: HEAVY GAUGE WELDED STEEL FRAME
2. STANDARD FINISH: TELCO GRAY POWDER COAT (OTHER COLORS AVAILABLE, SEE PART NUMBER LEGEND)
3. IT IS RECOMMENDED TO SUPPORT RACKS TALLER THAN 8 FT. FROM TOP IN ADDITION TO FLOOR MOUNTING.
4. APPROXIMATE UNPACKAGED WEIGHT: 70 LBS (84" TALL RACK)

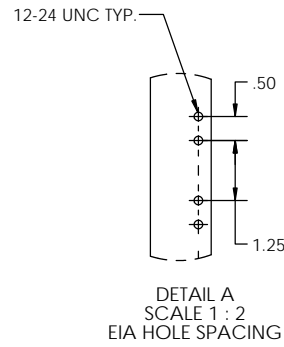
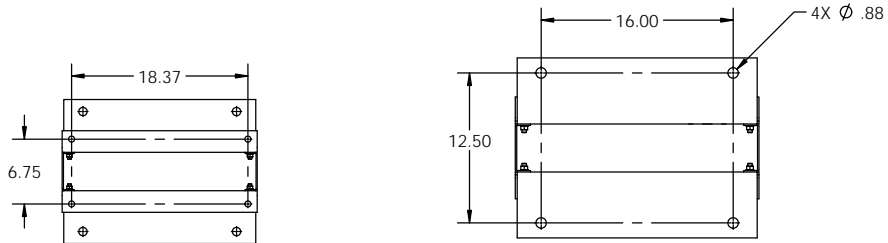

**EQUIPMENT RACK PART NUMBER LEGEND**

EQR 1 A 084 A A

RACK COLOR	
A	TELCO GRAY
B	BLACK
C	BLUE
D	WHITE
E	CREAM
F	KONE GRAY

HOLE SPACING	
A	EIA

RACK HIEGHT		
	H	RU(EIA)
060	5'	30
066	5'6"	34
072	6'	37
078	6'6"	41
084	7'	44
090	7'6"	47
096	8'	51
108	9'	58
138	11'6"	75

RACK WIDTH	
A	19" PANEL MOUNTING

RACK STYLE	
1	BOLTED

SECTION B-B  
SCALE 1 : 8

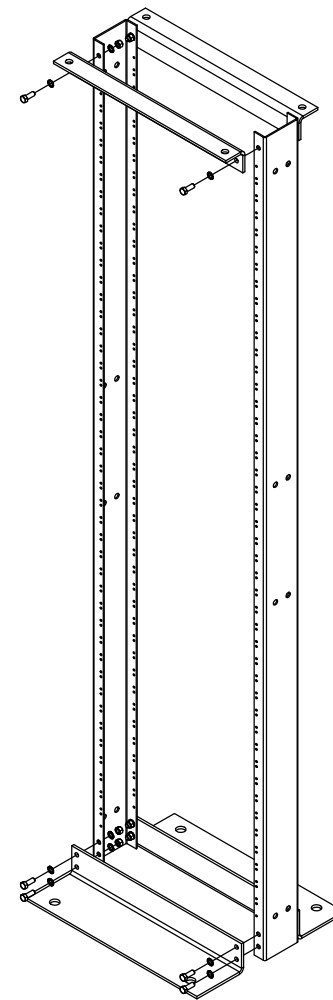
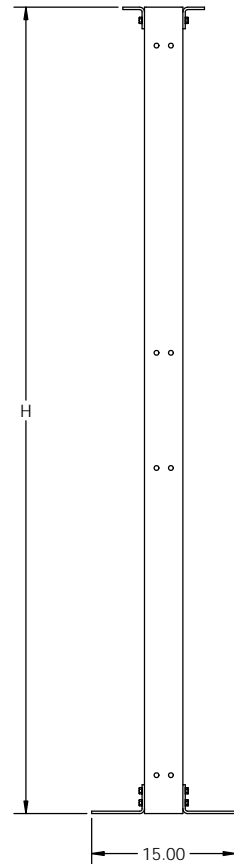
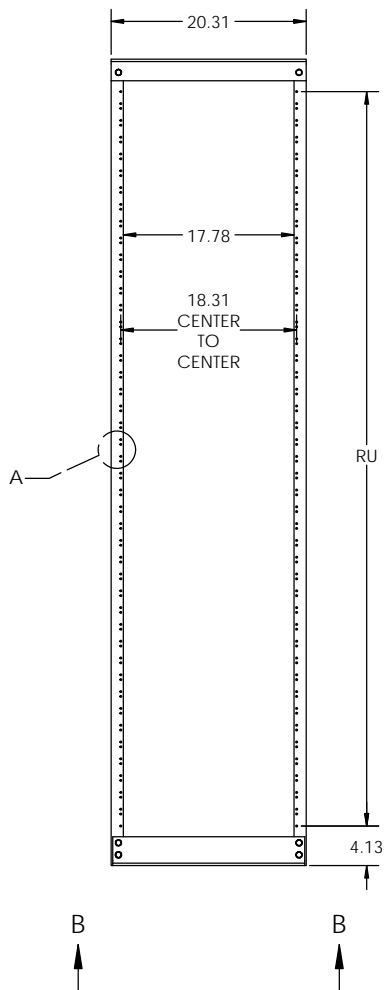

EIA RACK

PROPRIETARY AND CONFIDENTIAL  
THE INFORMATION CONTAINED IN THIS DRAWING IS THE SOLE PROPERTY OF ELECTRONIC SYSTEMS SUPPORT. ANY REPRODUCTION IN PART OR AS A WHOLE WITHOUT THE WRITTEN PERMISSION OF ELECTRONIC SYSTEMS SUPPORT IS PROHIBITED.

UNLESS OTHERWISE SPECIFIED: DIMENSIONS ARE IN INCHES		<b>Electronic Systems Support</b> www.ess.to		3233 W. Kingsley Rd. Garland, Texas 75041 PH. 972-272-2468 FAX 972-276-9844	
TITLE: <b>EQUIPMENT RACK BOLTED, 19", 84" TALL</b>					
PROJECTION:	NAME: _____	DATE: 4/13/16	SIZE: <b>C</b>	DWG. NO.: <b>EQR1Axxxxx-SPEC</b>	REV: <b>B</b>
DRAWN BY: LEM			SCALE: 1:12	SHEET 1 OF 2	

NOTES:

1. MATERIAL: HEAVY GAUGE WELDED STEEL FRAME
2. STANDARD FINISH: TELCO GRAY POWDER COAT (OTHER COLORS AVAILABLE, SEE PART NUMBER LEGEND)
3. IT IS RECOMMENDED TO SUPPORT RACKS TALLER THAN 8 FT. FROM TOP IN ADDITION TO FLOOR MOUNTING.
4. APPROXIMATE UNPACKAGED WEIGHT: 70 LBS (84" TALL RACK)

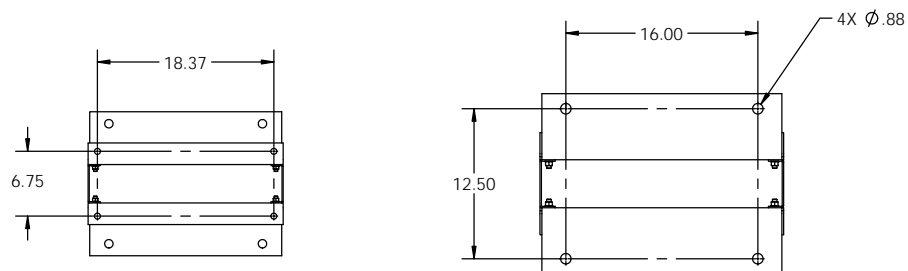

SECTION C-C  
SCALE 1 : 8

DETAIL D  
SCALE 1 : 2  
WECO HOLE SPACING

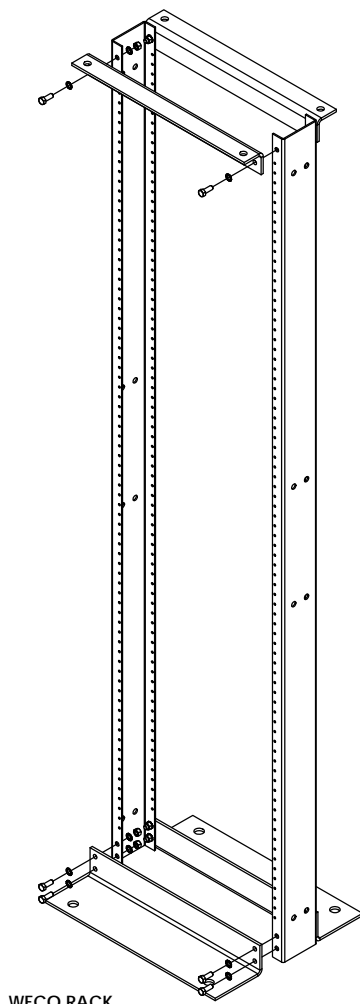
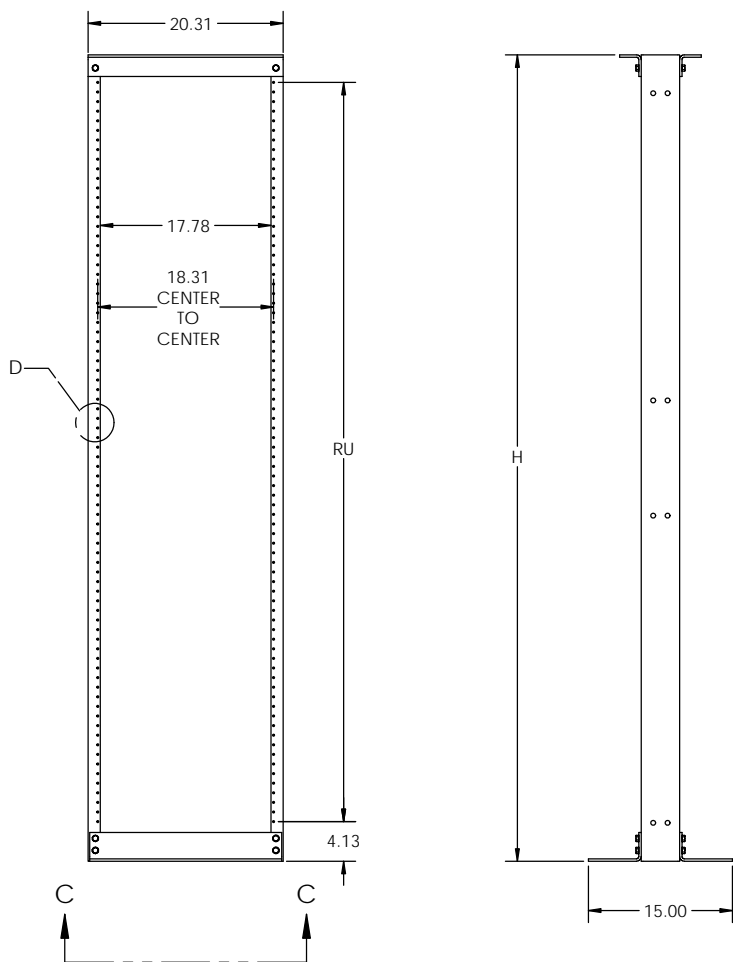

WECO RACK

EQUIPMENT RACK PART NUMBER LEGEND

EQR 1 A 084 B A

RACK COLOR	
A	TELCO GRAY
B	BLACK
C	BLUE
D	WHITE
E	CREAM
F	KONE GRAY

HOLE SPACING	
B	WECO

RACK HIEGHT		
	H	RU(WECO)
060	5'	27
066	5'6"	30
072	6'	33
078	6'6"	36
084	7'	39
090	7'6"	42
096	8'	45
108	9'	51
138	11'6"	66

RACK WIDTH	
A	19" PANEL MOUNTING

RACK STYLE	
1	BOLTED

PROPRIETARY AND CONFIDENTIAL  
THE INFORMATION CONTAINED IN THIS DRAWING IS THE SOLE PROPERTY OF ELECTRONIC SYSTEMS SUPPORT. ANY REPRODUCTION IN PART OR AS A WHOLE WITHOUT THE WRITTEN PERMISSION OF ELECTRONIC SYSTEMS SUPPORT IS PROHIBITED.

UNLESS OTHERWISE SPECIFIED: DIMENSIONS ARE IN INCHES		
PROJECTION:		
DRAWN BY:	LEM	DATE: 4/13/16

<b>Electronic Systems Support</b> www.ess.to		3233 W. Kingsley Rd. Garland, Texas 75041 PH. 972-272-2468 FAX 972-276-9844	
TITLE: EQUIPMENT RACK BOLTED, 19", 84" TALL			
SIZE: C	DWG. NO.: EQR1Axxxxx-SPEC	REV: B	
SCALE: 1:12		SHEET 2 OF 2	