

FRONT VIEW

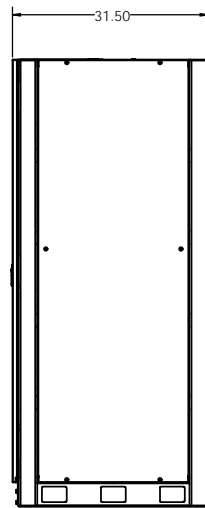

SIDE VIEW

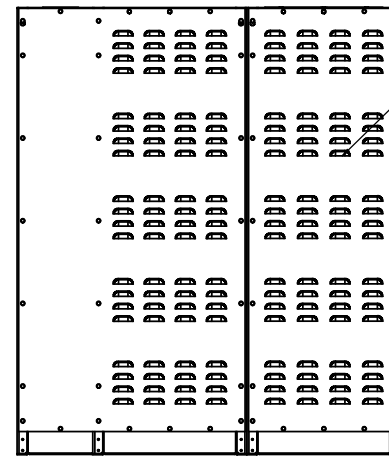

REAR VIEW

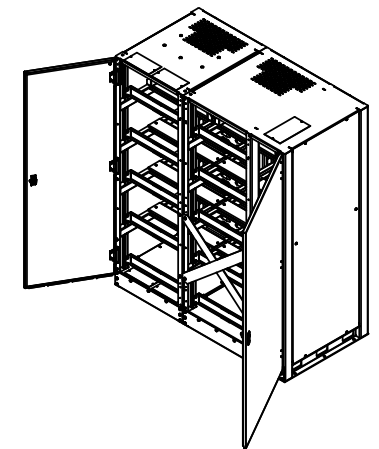

CABINET NOTES:

1. NEMA 1 DESIGN.
2. EMPTY CABINET WEIGHT: 910 LBS. (381KG) TOTAL WEIGHT (2 CABINETS) ONE 480V STRING.
3. UL 1778 LISTED AND FULLY TESTED AT THE FACTORY PRIOR TO SHIPPING.
4. FULLY WELDED FRAME. MANUFACTURED FROM HEAVY GAUGE STEEL.
5. POWDER COATED WITH A CORROSION RESISTANT, EPOXY HYBRID POWDER USING A FIVE STAGE EMERSION PRETREATMENT PROCESS.
6. BATTERIES CAN BE ACCESSED FROM FRONT, REAR, AND BOTH SIDES.
7. CUSTOM DESIGNED PALLETS FOR SHIPPING ANYWHERE, LOCALLY AND GLOBALLY (UPON REQUEST).
8. BATTERY CABINET CAN BE MOVED WITH A NORMAL PALLET JACK FROM FRONT AND REAR.
9. STANDARD AND CUSTOM SPILL CONTAINMENT OPTIONS ARE AVAILABLE.
10. SEISMICALLY CERTIFIED TO IBC (2012), ASCE 7-10, AND CBC (2010) CODES. DESIGN MEETS DEFAULT SEISMIC DESIGN CATEGORY D ($S_s=2.9$), IMPORTANCE FACTOR 1.5, AND HORIZONTAL STATIC ACCELERATION OF .817g.

PROPRIETARY AND CONFIDENTIAL
THE INFORMATION CONTAINED IN THIS DRAWING IS THE SOLE PROPERTY OF ELECTRONIC SYSTEMS SUPPORT. ANY REPRODUCTION IN PART OR AS A WHOLE WITHOUT THE WRITTEN PERMISSION OF ELECTRONIC SYSTEMS SUPPORT IS PROHIBITED.

UNLESS OTHERWISE SPECIFIED: DIMENSIONS ARE IN INCHES		Electronic Systems Support www.ess.to		3233 W. Kingsley Rd. Garland, Texas 75041 PH. 972-272-2468 FAX 972-276-9844	
TITLE: CABINET, BATTERY, 16V, EFS5A, 6X5, SIDE BREAKER, 925/800					
PROJECTION:	NAME	DATE	SIZE	DWG. NO.	REV
DRAWN BY: RNA		09-17-12	D	EFS5A-SPEC	C
SCALE: 1:16				SHEET 1 OF 3	

BREAKER DETAIL

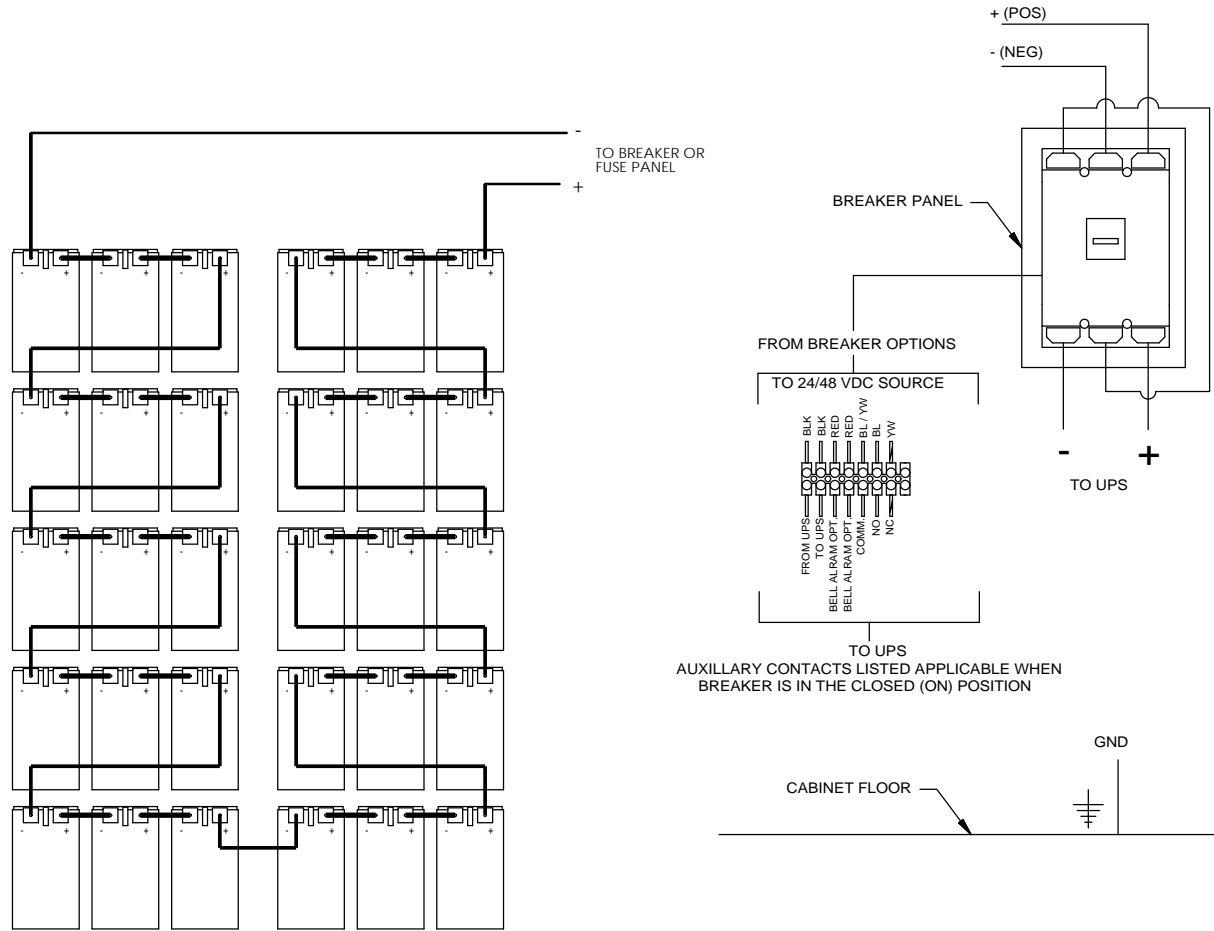

FUSE OPTION

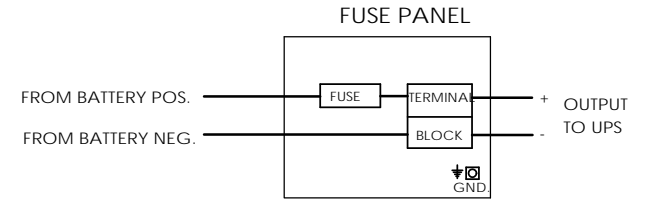

BATTERY CONFIGURATION TABLE		
	BATTERY MANUFACTURER	MAXIMUM NUMBER OF BATTERIES PER CABINET
	ENERSYS	
BATTERY MODEL NUMBER	16HX800F-FR	30
	16HX925F-FR	

TO UPS
AUXILLARY CONTACTS LISTED APPLICABLE WHEN BREAKER IS IN THE CLOSED (ON) POSITION

ELECTRICAL NOTES:

1. ALL CABLES ARE UL LISTED.
2. ALL BREAKERS ARE UL RECOGNIZED.
3. ALL FUSES ARE UL RECOGNIZED, TYPE A50P, A70P OR EQUIVALENT. (FUSED CABINETS ARE NOT LISTED IN UL FILE). ALWAYS REPLACE WITH SAME TYPE OR ITS EQUIVALENT.
4. TERMINAL BLOCKS ARE UL RECOGNIZED, 600V RATED.
5. CABINETS ARE SHIPPED WITH THE BREAKER IN THE TRIPPED POSITION.
6. CABINET GROUND CONNECTION IS A 5/16-18 THREADED STUD.
7. CABLES BETWEEN BATTERY CABINET TO UNINTERRUPTIBLE POWER SUPPLY ARE OPTIONAL.

PROPRIETARY AND CONFIDENTIAL
THE INFORMATION CONTAINED IN THIS DRAWING IS THE SOLE PROPERTY OF ELECTRONIC SYSTEMS SUPPORT. ANY REPRODUCTION IN PART OR AS A WHOLE WITHOUT THE WRITTEN PERMISSION OF ELECTRONIC SYSTEMS SUPPORT IS PROHIBITED.



UNLESS OTHERWISE SPECIFIED: DIMENSIONS ARE IN INCHES		Electronic Systems Support www.ess.to		3233 W. Kingsley Rd. Garland, Texas 75041 PH. 972-272-2468 FAX 972-276-9844	
TITLE: CABINET, BATTERY, 16V, EFS5A, 6X5, SIDE BREAKER, 925/800					
PROJECTION:	DRAWN BY: RNA	NAME: RNA	DATE: 09-17-12	SIZE: D	DWG. NO.: EFS5A-SPEC
				SCALE: 1:16	REV: C
				SHEET 2 OF 3	

ESS FRONT TERMINAL CABINET SYSTEM MATRIX											
ESS EF55A CABINET WITH BREAKER SYSTEM PART NUMBERS											
E F S 5 A A P 30 HX925 B 04 A											
DIGIT 1	DIGIT 2	DIGIT 3	DIGIT 4	DIGIT 5	DIGIT 6	DIGIT 7	DIGIT 8-9	DIGIT 10-14	DIGIT 15	DIGIT 16-17	DIGIT 18
CABINET MODEL											
	TYPE OF BATTERY	TYPE OF CABINET OR RACK	NUMBER OF TIERS	BATTERY TYPE	COLOR	HEIGHT (INCHES)	BATTERY QUANTITY	BATTERY MODEL PER MANUFACTURER	BREAKER OR FUSE	AMPS	BREAKER OPTION
E = ESS STANDARD	F = FRONT TERMINAL	S = CABINET W/SIDE BREAKER	5 = 5 TIER OF BATTERIES	A = 16V FT 928/800	**A = BLACK	C = 80.0	30	ENERSYS	B = BREAKER	01 = 1000 AMPS	A = 24 VDC SHUNT TRIP, AUX CONTACT
C = CENTER TAP CABLING					B = BEIGE	D = 79.0	27	HX925 - 16HX925F-FR	H = BREAKER W/HANDLE OPTION	02 = 800 AMPS	B = 48 VDC SHUNT TRIP, AUX CONTACT
S = SPLIT BUS CABLING					C = LIEBERT GRAY	E = 78.7	24	HX800 - 16HX800F-FR		03 = 700 AMPS	C = 24 VDC UVR, AUX CONTACT
					D = MITSUBISHI BEIGE	F = 78.4	18			04 = 600 AMPS	D = 48 VDC UVR, AUX CONTACT
					E = MGE WHITE	G = 78.00				05 = 500 AMPS	E = 120 VDC SHUNT TRIP, AUX CONTACT
					F = TOSHIBA BLACK	H = 77.3				06 = 450 AMPS	F = 240 VDC SHUNT TRIP, AUX CONTACT
					G = GE WHITE	J = 76.8				07 = 400 AMPS	G = 120 VDC UVR, AUX CONTACT
					H = LIEBERT BLACK	K = 75.3				08 = 350 AMPS	H = 240 VDC UVR, AUX CONTACT
					I = EATON BLACK	L = 75.0				09 = 300 AMPS	J = 24VDC UVR W/BELL ALARM
					J = LIGHT GRAY	M = 74.8				10 = 250 AMPS	K = BELL ALARM
						N = 73.5				11 = 225 AMPS	
						**P = 72.0				12 = 200 AMPS	
										13 = 175 AMPS	
										14 = 150 AMPS	
										15 = 125 AMPS	
										16 = 100 AMPS	
										17 = 75 AMPS	
										18 = 50 AMPS	
										19 = 40 AMPS	
										20 = 30 AMPS	
▶ **REPRESENTS STANDARD COLOR FOR ALL ESS CABINETS (DIGIT 6)											
▶ **REPRESENTS ESS STANDARD HEIGHT OF TOP TERMINAL BATTERY CABINETS (DIGIT 7)											

PART NUMBER GUIDE:

1. REFERENCE THE BATTERY PART NUMBER GUIDE TABLE WHEN ORDERING A CABINET.
 2. WHEN PLACING ORDER, INDICATE THE QTY OF CABINETS. NO DASHES ARE TO BE INCLUDED IN PART NUMBER. OVERALL PART NUMBER OF SYSTEM IS ALWAYS 18 DIGITS LONG.
 3. THE BASE NUMBER (DIGITS 1-5) WILL ALWAYS BE THE SAME.
 4. DIGITS 6-7 WILL FOLLOW THE BASE NUMBER INDICATING THE COLOR AND HEIGHT OF THE CABINET.
 5. DIGITS 8-18 MAKE UP THE REST OF THE SYSTEM PART NUMBER WHICH INCLUDE OPTIONS FOR BATTERY QUANTITIES, BATTERY MODEL, AND BREAKER OPTIONS.
 6. EXAMPLE: **EF55AAP** - THIS REPRESENTS A STANDARD **EF55A** CABINET, WITH A POWDER COAT FINISH OF STANDARD BLACK AND 72.00" HEIGHT.
- ▶ PLEASE NOTE, ONLY STANDARD CABINETS (COLOR AND HEIGHT) ARE IN STOCK. MINIMUM ORDERS OF 20 OR MORE CABINETS ARE REQUIRED FOR NON STANDARD CABINETS UNLESS IT IS THROUGH OEM CONTRACTS.

PROPRIETARY AND CONFIDENTIAL
 THE INFORMATION CONTAINED IN THIS DRAWING IS THE SOLE PROPERTY OF ELECTRONIC SYSTEMS SUPPORT. ANY REPRODUCTION IN PART OR AS A WHOLE WITHOUT THE WRITTEN PERMISSION OF ELECTRONIC SYSTEMS SUPPORT IS PROHIBITED.

UNLESS OTHERWISE SPECIFIED: DIMENSIONS ARE IN INCHES		 www.ess.to		3233 W. Kingsley Rd. Garland, Texas 75041 PH. 972-272-2468 FAX 972-276-9844	
TITLE: CABINET, BATTERY, 16V, EF55A, 6X5, SIDE BREAKER, 925/800					
PROJECTION: 	NAME: RNA	DATE: 09-17-12	SIZE: D	DWG. NO.: EF55A-SPEC	REV: C
SCALE: 1:16				SHEET 3 OF 3	