

SECTION A-A

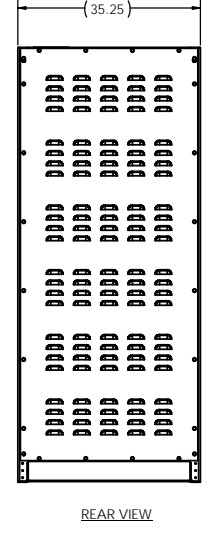
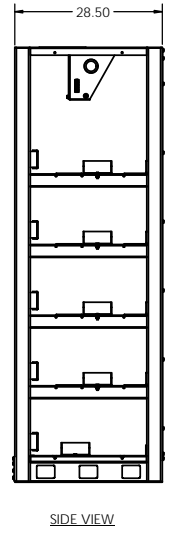
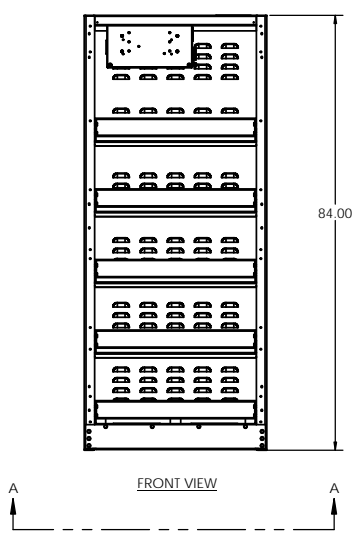
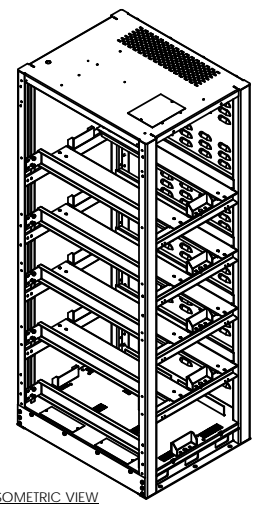

RACK NOTES:

1. EMPTY RACK WEIGHT: 465 LBS.
2. FULLY WELDED FRAME. MANUFACTURED FROM HEAVY GAUGE STEEL.
3. ALL BATTERY TERMINALS HAVE POLYCARBONATE COVER.
4. OPTIONAL WALL MOUNTED BREAKER ENCLOSURES AVAILABLE.
5. POWDER COATED WITH A CORROSION RESISTANT POWDER USING A FIVE STAGE EMERSION PRETREATMENT PROCESS.
6. BATTERIES CAN BE ACCESSED FROM FRONT, REAR, AND BOTH SIDES.
7. CUSTOM DESIGNED PALLETS FOR SHIPPING ANYWHERE LOCALLY AND GLOBALLY (UPON REQUEST).
8. BATTERY RACK CAN BE MOVED WITH A NORMAL PALLET JACK FROM FRONT AND REAR.
9. STANDARD AND CUSTOM SPILL CONTAINMENT OPTIONS ARE AVAILABLE.

PROPRIETARY AND CONFIDENTIAL
THE INFORMATION CONTAINED IN THIS DRAWING IS THE SOLE PROPERTY OF ELECTRONIC SYSTEMS SUPPORT. ANY REPRODUCTION IN PART OR AS A WHOLE WITHOUT THE WRITTEN PERMISSION OF ELECTRONIC SYSTEMS SUPPORT IS PROHIBITED.

UNLESS OTHERWISE SPECIFIED: DIMENSIONS ARE IN INCHES		Electronic Systems Support www.ess.to		3233 W. Kingsley Rd. Garland, Texas 75041 PH. 972-272-2468 FAX 972-276-9844	
PROJECTION:				TITLE: BATTERY RACK, 12V, 360V, 324V, 288V, 240V	
DRAWN BY	NAME	DATE	SIZE	DWG. NO.	REV
	RNA	3-5-13	D	EFR51-SPEC	B
SCALE: 1:12				SHEET 1 OF 3	

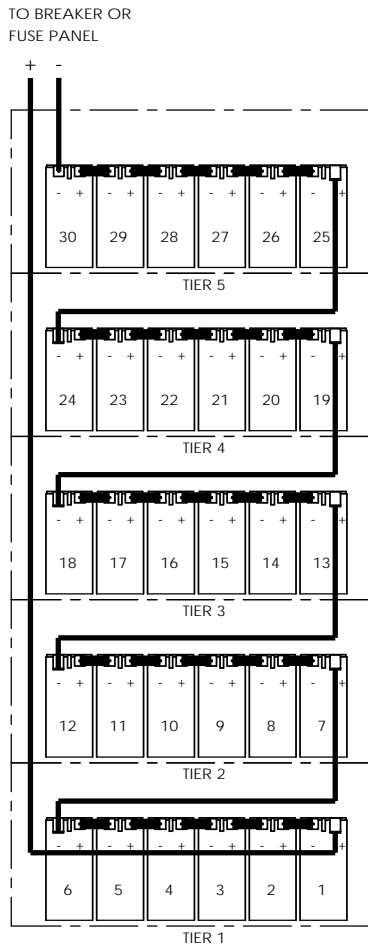

TYP 360VDC WIRING

BREAKER DETAIL

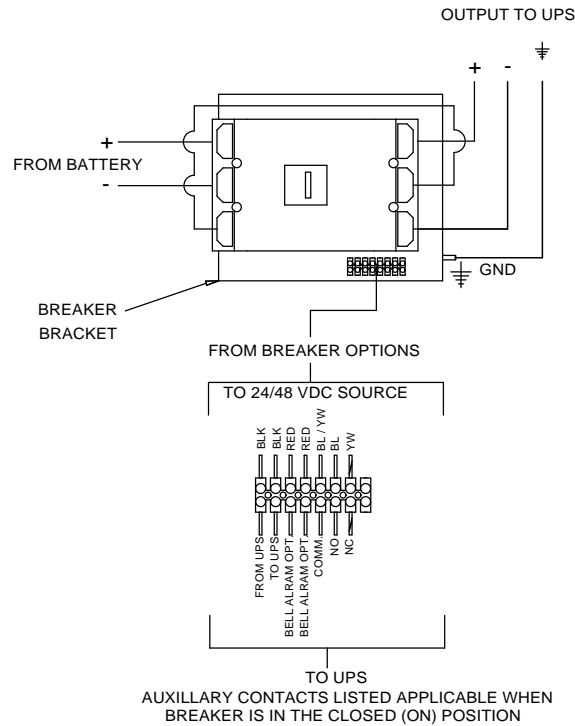

FUSE OPTION

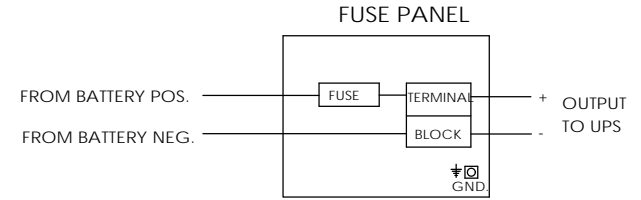

ELECTRICAL NOTES:

1. ALL CABLES ARE UL LISTED.
2. ALL BREAKERS ARE UL RECOGNIZED.
3. ALL FUSES ARE UL RECOGNIZED, TYPE A50P, A70P OR EQUIVALENT. ALWAYS REPLACE WITH SAME TYPE OR ITS EQUIVALENT.
4. TERMINAL BLOCKS ARE UL RECOGNIZED, 600V RATED.
5. RACKS ARE SHIPPED WITH THE BREAKER IN THE TRIPPED POSITION.
6. RACKS GROUND CONNECTION IS A 5/16-18 THREADED STUD.
7. CABLES BETWEEN BATTERY RACKS TO UNINTERRUPTIBLE POWER SUPPLY ARE OPTIONAL.

PROPRIETARY AND CONFIDENTIAL
THE INFORMATION CONTAINED IN THIS DRAWING IS THE SOLE PROPERTY OF ELECTRONIC SYSTEMS SUPPORT. ANY REPRODUCTION IN PART OR AS A WHOLE WITHOUT THE WRITTEN PERMISSION OF ELECTRONIC SYSTEMS SUPPORT IS PROHIBITED.

UNLESS OTHERWISE SPECIFIED: DIMENSIONS ARE IN INCHES		Electronic Systems Support www.ess.to		3233 W. Kingsley Rd. Garland, Texas 75041 PH. 972-272-2468 FAX 972-276-9844	
TITLE: BATTER RACK, 12V, 360V, 324V, 288V, 240V					
PROJECTION:	NAME	DATE	SIZE	DWG. NO.	REV
DRAWN BY: RNA		3-5-13	D	EFR51-SPEC	B
SCALE: 1:12				SHEET 2 OF 3	

ESS FRONT TERMINAL RACK SYSTEM MATRIX											
ESS EFR51 RACK SYSTEM PART NUMBERS											
E F R S 1 A A 30 550ET B 04 A											
DIGIT 1	DIGIT 2	DIGIT 3	CABINET MODEL		DIGIT 6	DIGIT 7	DIGIT 8-9	DIGIT 10-14	DIGIT 15	DIGIT 16-17	DIGIT 18
	TYPE OF BATTERY	TYPE OF CABINET OR RACK	NUMBER OF TIERS	BATTERY TYPE	COLOR	HEIGHT (INCHES)	BATTERY QUANTITY	BATTERY MODEL PER MANUFACTURER	BREAKER OR FUSE	AMPS	BREAKER OPTION
E = ESS STANDARD	F = FRONT TERMINAL	R = RACK	5 = 5 TIER OF BATTERIES	1 = 12V FT (NORMAL)	**A = BLACK	**A = 84	30	ENERSYS	B = BREAKER	04 = 600 AMPS	A = 24 VDC SHUNT TRIP, AUX CONTACT
C = CENTER TAP CABLING					B = BEIGE		24	XE101 - 12XE1010F-FR		05 = 500 AMPS	B = 48 VDC SHUNT TRIP, AUX CONTACT
S = SPLIT BUS CABLING					C = LIEBERT GRAY			XE111 - 12XE1110F-FR		06 = 450 AMPS	C = 24 VDC UVR, AUX CONTACT
					D = MITSUBISHI BEIGE			XE115 - 12XE1150F-FR		07 = 400 AMPS	D = 48 VDC UVR, AUX CONTACT
					E = MGE WHITE			EAST PENN		08 = 350 AMPS	E = 120 VDC SHUNT TRIP, AUX CONTACT
					F = TOSHIBA BLACK			350ET - HR3500ET		09 = 300 AMPS	F = 240 VDC SHUNT TRIP, AUX CONTACT
					G = GE WHITE			550ET - HR5500ET		10 = 250 AMPS	G = 120 VDC UVR, AUX CONTACT
					H = LIEBERT BLACK			C & D		11 = 225 AMPS	H = 240 VDC UVR, AUX CONTACT
					I = EATON BLACK			355MR - UPS12-355MRF		12 = 200 AMPS	J = 24VDC UVR W/BELL ALARM
					J = LIGHT GRAY			615MR - UPS12-615MRF		13 = 175 AMPS	K = BELL ALARM
								700MR - UPS12-700MRF		14 = 150 AMPS	
								41MRX - UPS12-410MRXF		15 = 125 AMPS	
								1KMRX - UPS12-1000MRXF		16 = 100 AMPS	
								NORTHSTAR		17 = 75 AMPS	
								450RT - 12-450RT		18 = 50 AMPS	
								650RT - 12-650RT		19 = 40 AMPS	
								730RT - 12-730RT		20 = 30 AMPS	
								GNB/EXIDE			
								M12V155FT			
								M12V180FT			
								S12V645FT			
								S12V735FT			



**REPRESENTS STANDARD COLOR FOR ALL ESS RACKS (DIGIT 6)

**REPRESENTS ESS STANDARD HEIGHT OF TOP TERMINAL BATTERY RACKS (DIGIT 7) ONLY HEIGHT AVAILABLE FOR THIS RACK

PART NUMBER GUIDE:

1. REFERENCE THE BATTERY PART NUMBER GUIDE TABLE WHEN ORDERING A RACK.
 2. WHEN PLACING ORDER, INDICATE THE QTY OF RACKS. NO DASHES ARE TO BE INCLUDED IN PART NUMBER. OVERALL PART NUMBER OF SYTEM IS ALWAYS 18 DIGITS LONG.
 3. THE BASE NUMBER (DIGITS 1-5) WILL ALWAYS BE THE SAME.
 4. DIGITS 6-7 WILL FOLLOW THE BASE NUMBER INDICATING THE COLOR AND HEIGHT OF THE RACK.
 5. DIGITS 8-18 MAKE UP THE REST OF THE SYSTEM PART NUMBER WHICH INCLUDE OPTIONS FOR BATTERY QUANTITIES, BATTERY MODEL, AND BREAKER OPTIONS.
 6. EXAMPLE: **EFR51AA** - THIS REPRESENTS A STANDARD **EFR51** RACK, WITH A POWDER COAT FINISH OF STANDARD BLACK AND 84.00" HEIGHT.
- PLEASE NOTE, ONLY STANDARD RACKS (COLOR AND HEIGHT) ARE IN STOCK. MINIMUM ORDERS OF 20 OR MORE RACKS ARE REQUIRED FOR NON STANDARD RACKS UNLESS IT IS THROUGH OEM CONTRACTS.

PROPRIETARY AND CONFIDENTIAL
 THE INFORMATION CONTAINED IN THIS DRAWING IS THE SOLE PROPERTY OF ELECTRONIC SYSTEMS SUPPORT. ANY REPRODUCTION IN PART OR AS A WHOLE WITHOUT THE WRITTEN PERMISSION OF ELECTRONIC SYSTEMS SUPPORT IS PROHIBITED.

UNLESS OTHERWISE SPECIFIED: DIMENSIONS ARE IN INCHES		 www.ess.to		3233 W. Kingsley Rd. Garland, Texas 75041 PH. 972-272-2468 FAX 972-276-9844	
TITLE: BATTER RACK, 12V, 360V, 324V, 288V, 240V				REV B	
PROJECTION: 		SIZE: D		DWG. NO.: EFR51-SPEC	
DRAWN BY: RNA		NAME:		DATE: 3-5-13	
SCALE: 1:12		SHEET 3 OF 3			